



12.3 inch Bar LCD Panel Series



GDS123DZX34HV-GF43

Dalian Good Display Co., Ltd.

Table of Contents

1. Record of Revision.....	3
2. General Specifications.....	4
3. Input/Output Terminals.....	5
4. Absolute Maximum Rating.....	6
7. Optical Characteristics.....	15
8. Environmental / Reliability Tests.....	19
9. Mechanical Drawing.....	20
10. Packing.....	21
11. TFT-LCD Module Inspection Criteria.....	22
12. Precautions for Use of LCD modules.....	27

2. General Specifications

	Feature	Spec
Characteristics	Size	12.3 inch
	Resolution	1920(horizontal)*720(Vertical)
	Interface	2 port LVDS
	Connect type	FH41-40S-0.5SH
	Display Colors	16.7M
	Technology type	a-Si
	Pixel pitch (mm)	0.1523*0.1523
	Pixel Configuration	R.G.B.-Stripe
	Display Mode	Normally Black
	LCD Driver IC	TBD
	CTP Driver IC	CYTMA568-70BUI
	Viewing Direction	ALL
Mechanical	LCM (W x H x D) (mm)	313.4*135.86*10.15
	Active Area(mm)	292.32 *109.62
	With /Without TSP	With CTP
	Weight (g)	476 g
	LED Numbers	80 LEDs

Note 1: Requirements on Environmental Protection: RoHs

Note 2: LCM weight tolerance: +/- 5%

3. Input/Output Terminals

LCD PIN-MAP

1	GND	Power ground
2	GND	Power ground
3	RXOIN0-	-LVDS differential data input (Odd data)
4	RXOIN0+	+LVDS differential data input (Odd data)
5	GND	Power ground
6	RXOIN1-	-LVDS differential data input (Odd data)
7	RXOIN1+	+LVDS differential data input (Odd data)
8	GND	Power ground
9	RXOIN2-	-LVDS differential data input (Odd data)
10	RXOIN2+	+LVDS differential data input (Odd data)
11	GND	Power ground
12	RXOCLKIN-	-LVDS differential clock input (Odd clock)
13	RXOCLKIN+	+LVDS differential clock input (Odd clock)
14	GND	Power ground
15	RXOIN3-	-LVDS differential data input (Odd data)
16	RXOIN3+	+LVDS differential data input (Odd data)
17	GND	Power ground
18	RXEIN0-	-LVDS differential data input (Even data)
19	RXEIN0+	+LVDS differential data input (Even data)
20	GND	Power ground
21	RXEIN1-	-LVDS differential data input (Even data)
22	RXEIN1+	+LVDS differential data input (Even data)
23	GND	Power ground
24	RXEIN2-	-LVDS differential data input (Even data)
25	RXEIN2+	+LVDS differential data input (Even data)
26	GND	Power ground
27	RXEIN3-	-LVDS differential data input (Even data)
28	RXEIN3+	+LVDS differential data input (Even data)
29	GND	Power ground
30	STVD	Feedback signal
31	GND	Power ground
32	RESET	Global reset pin
33	GND	Power ground
34	VDD	Power input
35	VDD	Power input

36	VDD	Power input
37	VDD	Power input
38	VDD	Power input
39	GND	Power ground
40	GND	Power ground

CTP PIN-MAP

Pin	Signal	Description
1	VDD	Power supply 3.3V
2	GND	Ground
3	RST	Reset Pin for CTP
4	SDA	I2C data input and output 2.8V
5	SCL	I2C clock input 2.8V
6	INT	Interrupt request to the host

4. Absolute Maximum Rating

Item	Symbol	MIN	Typ	MAX	Unit	Remark
Supply Voltage	VDD	-0.3	-	4	V	-
Operating Temperature	TOPR	-30	-	85	°C	-
Storage Temperature	TSTG	-40	-	95	°C	-

5. Electrical Characteristics

5.1 Driving TFT LCD Panel

Item	Symbol	MIN	TYP	MAX	Unit	Remark
Supply Voltage	VDD	3.0	3.3	3.6	V	
Input Signal Voltage	Low Level	VIL	GND	-	0.3x VDD	V
	High Level	VIH	0.7x VDD	-	VDD	V
Output Signal Voltage	Low Level	VIL	-	-	VSS+0.4	V
	High Level	VIH	VDD-0.4	-	-	V
(Panel+LSI) Power Consumption	Black Mode (60Hz)	-	-	-	nW	
	Standby	-	-	-	uW	

5.2 CTP Electrical Characteristics

FPC Design	Item	Description	Remark
COF	IC solution on TP Model	CYTMA568-70BUI	
	Touch Count Max	5 point	
	Display Resolution	1920*720	
	Interface Type	I2C	
	I2C Slave Address	OX70	
	Origin of Coordinate	Top left corner	

Parameter	Min	Typ	Max	Unit
Interface Signal Voltage	-	2.8	-	V
Power Voltage	-	3.3	-	V

5.3 LED Driving Conditions

Item	Symbol	MIN	TYP	MAX	Unit	Remark
Forward Current	I_F	-	480	520	mA	
Forward Voltage	V_F	28	30	32	V	
Backlight Power consumption	W_{BL}	-	15.36	17.16	W	
LED Lifetime		70000	-	-	Hrs	

Note 1: Each LED: $I_F = 60 \text{ mA}$, $V_F = 3.2 \pm 0.2 \text{ V}$.

Note 2: Optical performance should be evaluated at $T_a = 25^\circ \text{C}$ only.

Note 3: If LED is driven by high current, high ambient temperature & humidity condition. The life Time of LED will be reduced. Operating life means brightness goes down to 50% initial brightness. Typical operating life time is estimated data.

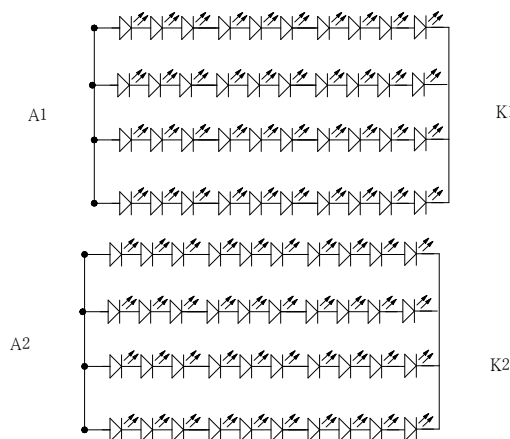

Figure: LED connection of backlight(Constant Current)

6. Interface Timing

6.1 b.Signal DC Electrical Characteristics

Parameter	Symbol	Min	Typ	Max	Unit	Notes
Differential input high threshold	R_{XVTH}	-	-	200	mV	$R_{XVCM}=1.2V$
Differential input low threshold	R_{XVTL}	-200	-	-	mV	$R_{XVCM}=1.2V$
Input voltage range (singled-end)	R_{XVIN}	0.7	-	1.6	V	
Input differential voltage	$ V_{ID} $	200	-	600	mV	
Differential Input Common Mode Voltage	R_{XVCM}	1.0	1.2	1.3	V	

Single-end Signal

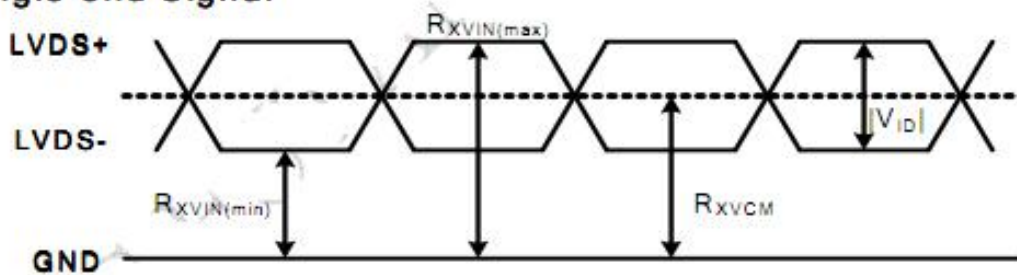

Differential Signal

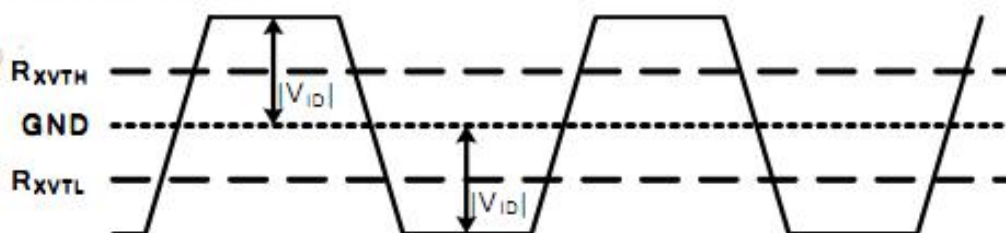

Fig. 4 LVDS DC characteristics diagram

6.2 AC Electrical Characteristics

a. Differential signal AC characteristics

Parameter	Symbol	Min.	Typ.	Max.	Unit	Remark
Clock frequency	R_{XFCLK}	44.7	47.5	61	MHz	
Input data skew margin	T_{RSKM}	-	-	200	ps	$ VID =200mV$ $RXVCM=1.2V$ Note1
Clock strobe width	T_{SW}	1200	-	-	ps	
Clock High Time	T_{LVCH}	-	$4/(7 * R_{XFCLK})$	-	ns	
Clock Low Time	T_{LVCL}	-	$3/(7 * R_{XFCLK})$	-	ns	

Note1. For the Data Skew Margin, "Input Signal Skew + Input Signal Jitter" must be smaller than T_{RSKM} .

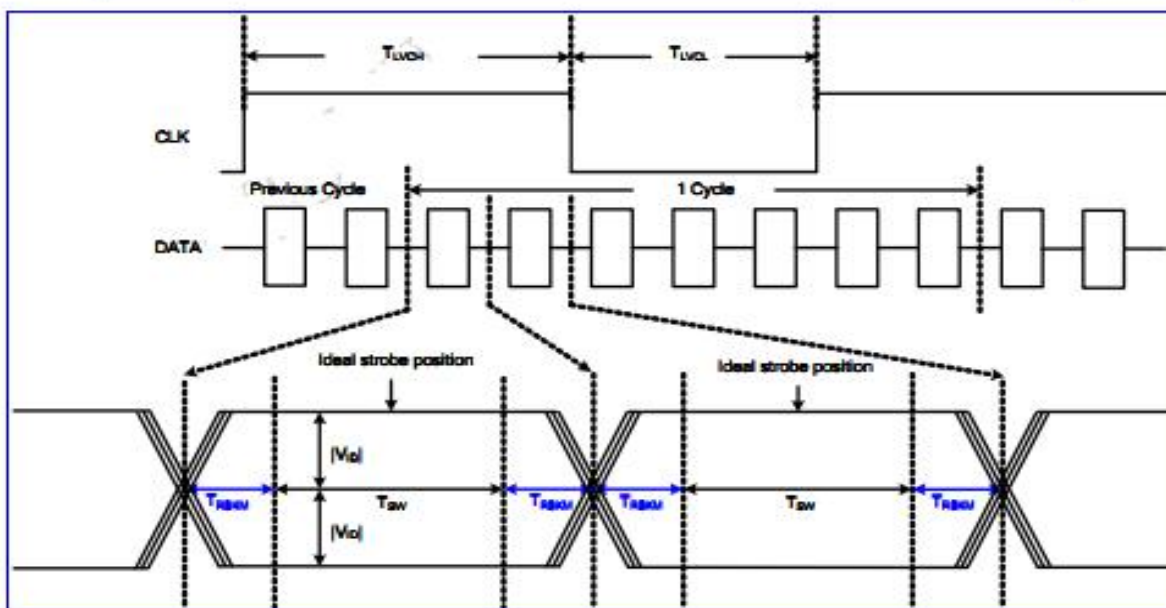
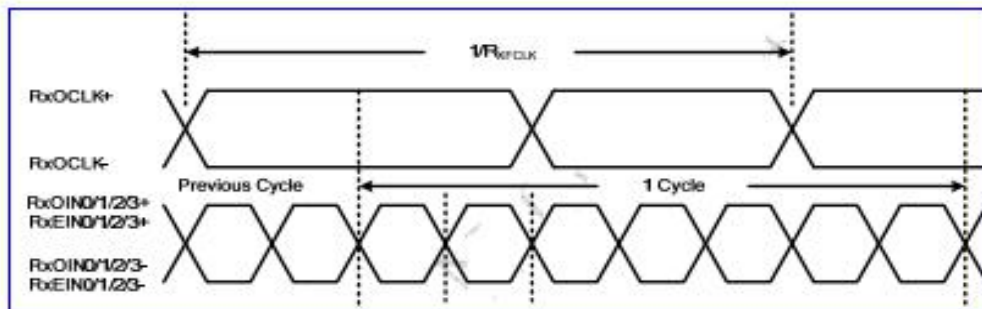

ALL RIGHTS STRICTLY RESERVED. ANY PORTION OF THIS PAPER SHALL NOT BE REPRODUCED, COPIED, OR TRANSFORMED TO ANY OTHER FORMS WITHOUT PERMISSION FROM AU OPTONICS CORP.

6.3 Data skew margin Differential Input Data Format

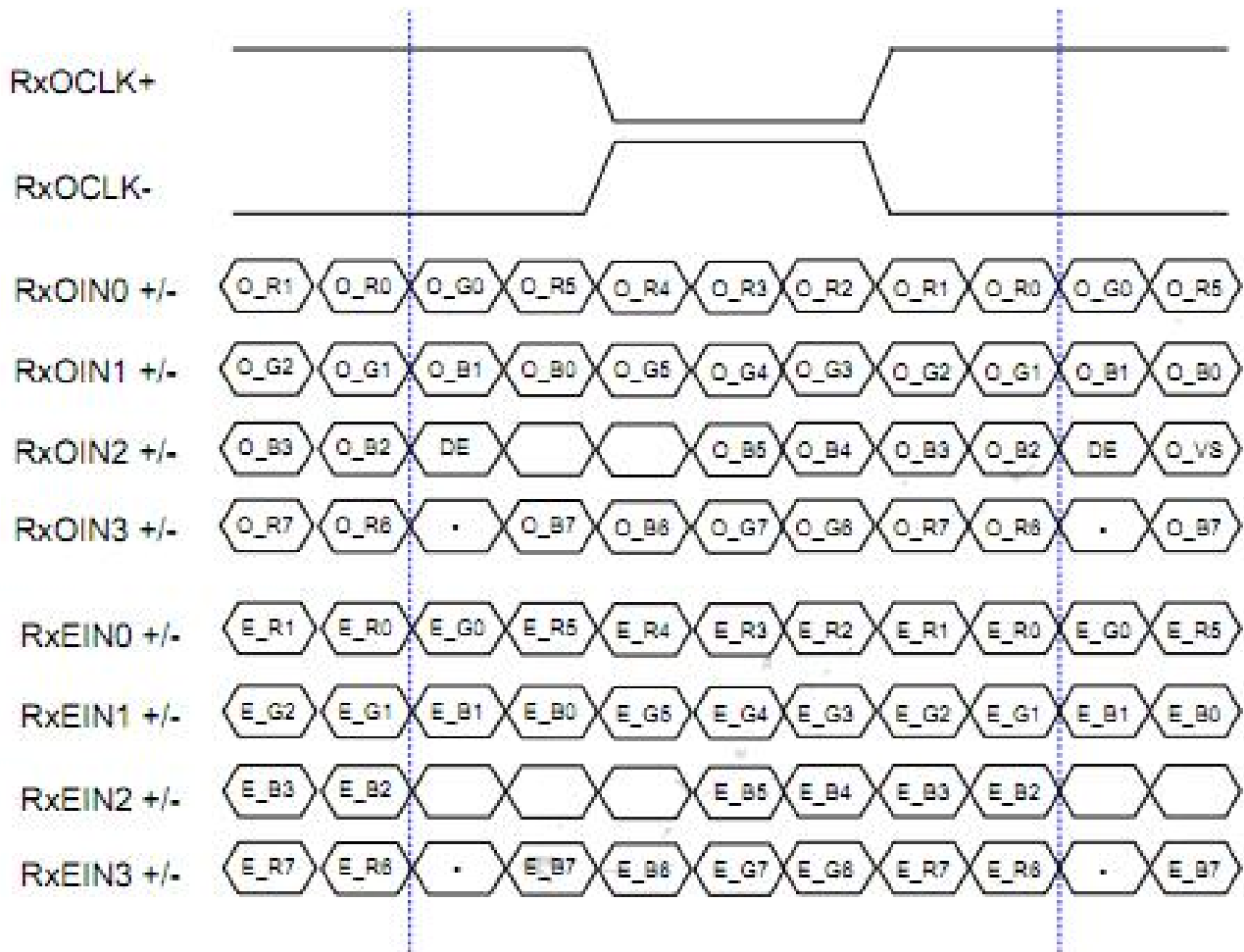

Fig.1 LVDS input data VESA format

6.4 Timing Condition

a. DE Mode

Item	Symbol	Min	Typ.	Max	Unit	Remark
Clock frequency	F_{DCLK}	44.7	47.5	61	MHz	
Horizontal period area	T_H	1020	1040	1200	DCLK	
Horizontal display area	T_{HD}	960	960	960	DCLK	
Horizontal blanking area	T_{HB}	60	80	240	DCLK	
Vertical period area	T_V	730	760	840	T_H	
Vertical display area	T_{VD}	720	720	720	T_H	
Vertical blanking area	T_{VB}	10	40	120	T_H	
Frame rate	F_R	55	60	65	Hz	

b. Timing Diagram

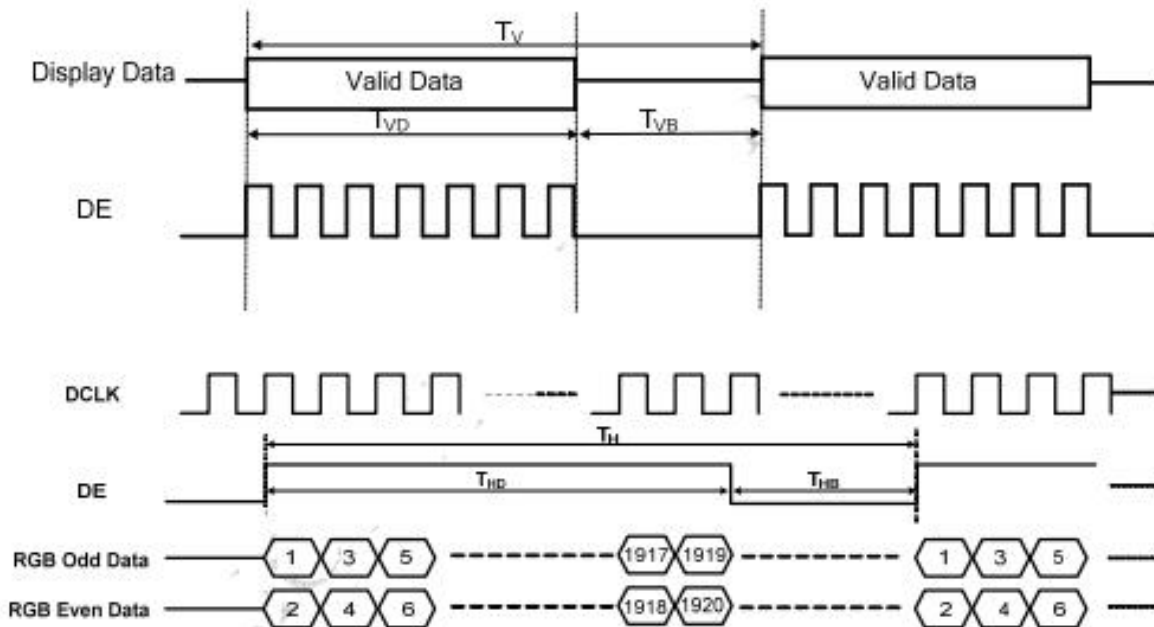

6.5 Feedback Signal Timing for Detected Function

Item	Symbol	Min	Typ	Max	Unit	Remark
STVD	V_{STVD-H}	VDD-0.3	--	VDD	V	$I_{STVD-H} = 200\mu A$
	V_{STVD-L}	GND	--	GND+0.3	V	$I_{STVD-L} = -200\mu A$
STVD frequency	F_{STVD}	55	60	65	HZ	
STVD period	T_{STVD}	15.4	16.6	18.2	ms	
STVD pulse width	T_{WSTVD}	19	21	23	us	

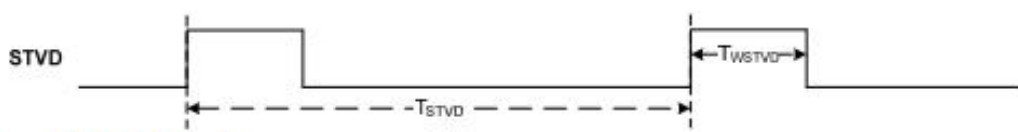

6.6 RESET Function

Item	Symbol	Min	Typ	Max	Unit	Remark
RESET	T1	1	--	20	ms	

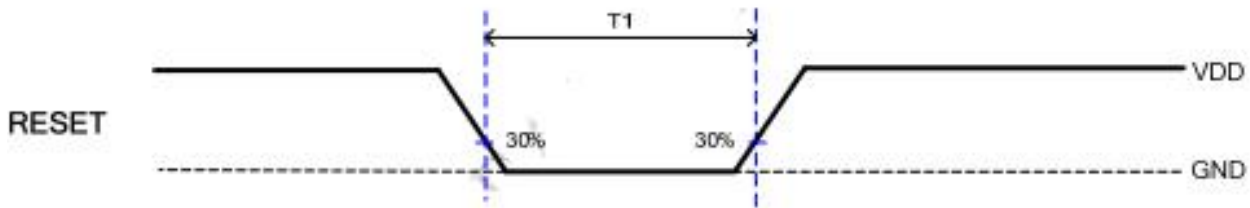

6.7 Power ON / OFF timing

The LCD adopts high voltage driver IC, so it could be permanently damaged under a wrong power on/off sequence. The suggested LCD power sequence is below:

a. Power ON sequence

Parameter	Value			Unit
	Min.	Typ.	Max.	
T1	0.5	--	15	ms
T2	1	--	20	ms
T3	0	--	20	ms
T4	500	--	--	ms

Power on sequence

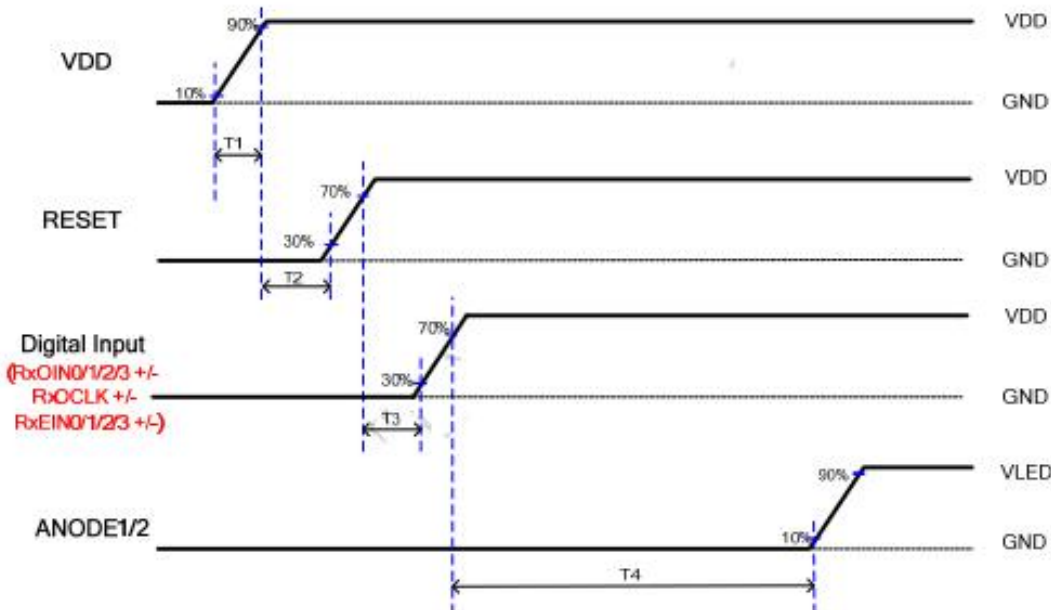

b. Power OFF sequence

Parameter	Value			Unit
	Min.	Typ.	Max.	
T1	200	--	--	ms
T2	0	--	20	ms
T3	1	--	20	ms

Power off sequence

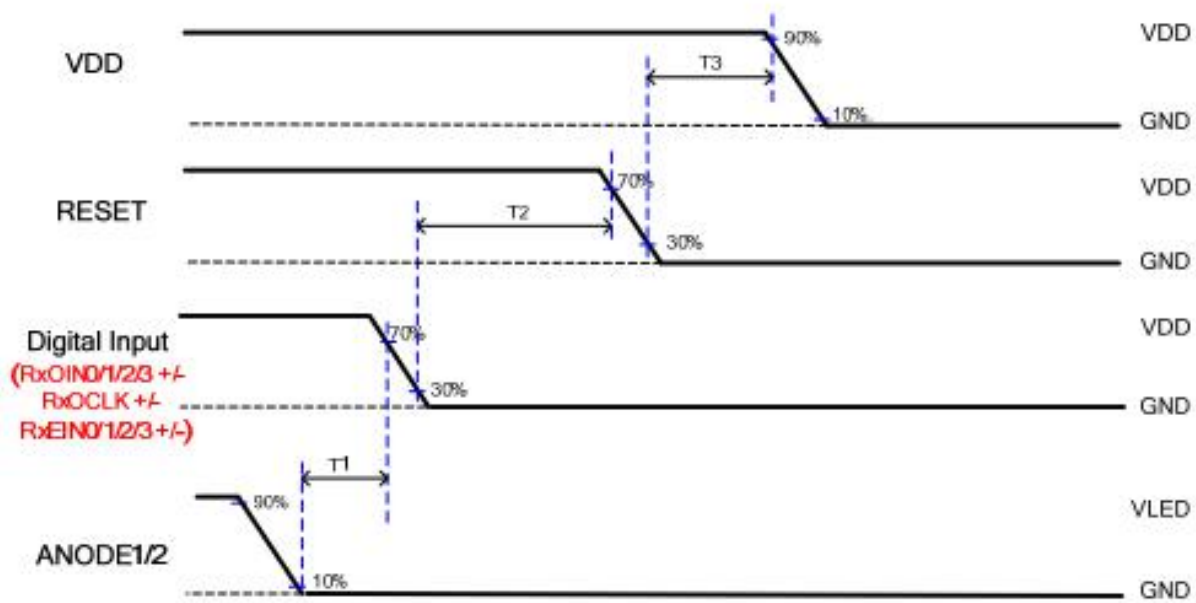

c. VDD ON / OFF

Parameter	Value			Unit
	Min.	Typ.	Max.	
T1	1000	--	-	ms

VDD ON / OFF

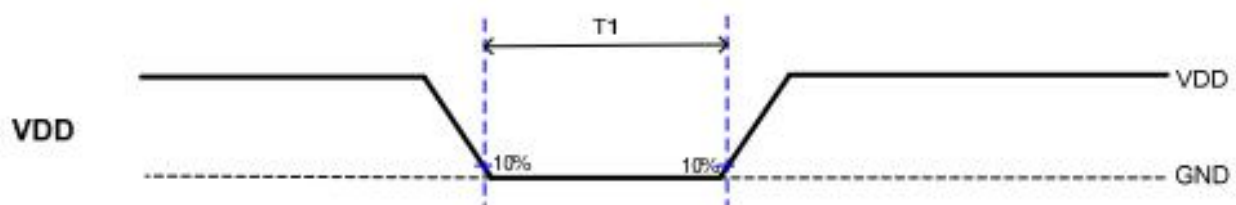

d. RESET ON / OFF

Parameter	Value			Unit
	Min.	Typ.	Max.	
T1	1000	--	-	ms

RESET ON / OFF

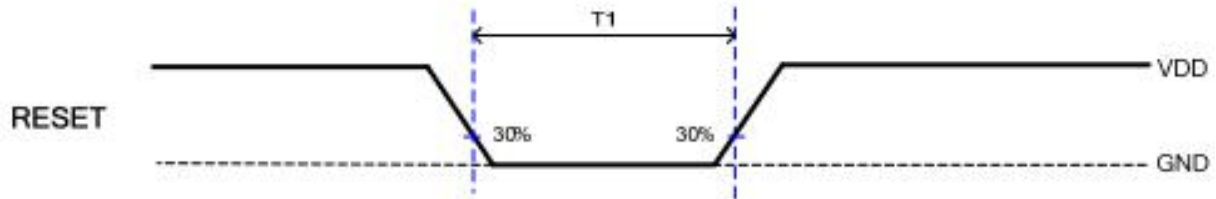

7. Optical Characteristics

Items	Symbol	Condition	Min.	Typ.	Max.	Unit	Remark	Note	
Response time	Tr+Tf	-	-	25	30	ms	FIG.1	Note4	
Contrast Ratio	CR		800	1000	-	-	FIG.2	Note1	
Surface luminance	LV	$\theta = 0^\circ$	750	800	-	cd/m ²	FIG.2	Note2	
Luminance uniformity	Yu	$\theta = 0^\circ$	80	-	-	%	FIG.2	Note3	
NTSC	-	$\theta = 0^\circ$	-	50	-	%	FIG.2	Note5	
Viewing angle	θ_T	Center CR \geq 10	-	85	-	deg	FIG.3	Note6	
	θ_B		-	85	-	deg	FIG.3		
	θ_L		-	85	-	deg	FIG.3		
	θ_R		-	85	-	deg	FIG.3		
Chromaticity	Red	R_X	TBD	TBD	TBD	-	FIG.2 CIE1931	Note5	
		R_Y	TBD	TBD	TBD	-			
	Green	G_X	$\theta = 0^\circ$	TBD	TBD	TBD			-
		G_Y	$\phi = 0^\circ$	TBD	TBD	TBD			-
	Blue	B_X	$T_a = 25^\circ$	TBD	TBD	TBD			-
		B_Y		TBD	TBD	TBD			-
	White	W_X		0.26	0.31	0.36			-
		W_Y		0.28	0.33	0.38			-

Note1. Definition of contrast ratio

Contrast ratio(Cr) is defined mathematically by the following formula. For more information see FIG.2.

$$\text{Contrast ratio} = \frac{\text{Luminance measured when LCD on the "White" state}}{\text{Luminance measured when LCD on the "Black" state}}$$

For contrast ratio, Surface Luminance, Luminance uniformity and CIE,the testing data is base on TOPCON' s BM-5 or BM-7 photo detector or compatible.

Note2. Definition of surface luminance.

Surface luminance is the luminance with all pixels displaying white. For more information see FIG.2.

Lv = Average Surface Luminance with all white pixels(P1,P2,P3,,Pn)

Note3. Definition of luminance uniformity

The luminance uniformity in surface luminance is determined by measuring luminance at each test position 1 through n, and then dividing the maximum luminance of n points luminance by minimum luminance of n points luminance.For more information see FIG.2.

$$YU = \frac{\text{Minimum surface luminance with all white pixels (P1,P2,P3,.....,Pn)}}{\text{Maximum surface luminance with all white pixels (P1,P2,P3,.....,Pn)}}$$

Note4. Definition of response time

The response time is defined as the LCD optical switching time interval between "White" state and "Black"state.Rise time (Tr) is the time between photo detector output intensity changed from 90% to 10%. And fall time (Tf) is the time between photo detector output intensity changed from 10% to 90%.

For additional information see FIG1.

Note5. Definition of color chromaticity (CIE1931)

CIE (x,y) chromaticity,The x,y value is determined by screen active area center position P5.For more information see FIG.2.

Note6. Definition of viewing angle

Viewing angle is the angle at which the contrast ratio is greater than 10. Angles are determined for the horizontal or x axis and the vertical or y axis with respect to the z axis which is normal to the LCD surface. For more information see FIG.3.

For viewing angle and response time testing, the testing data is base on Autronic-Melchers' s ConoScope or DMS series Instruments or compatible.

FIG.1. The definition of response Time

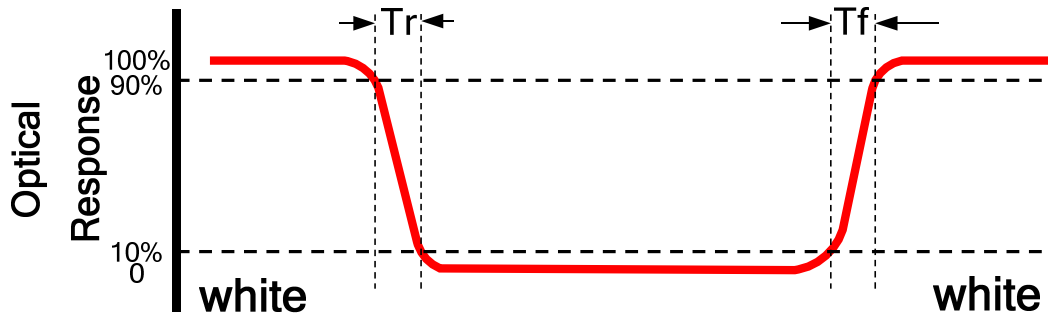

FIG.2. Measuring method for contrast ratio, surface luminance,

luminance uniformity, CIE (x,y) chromaticity

Size : $S \leq 5''$ (see Figure a) A : 5 mm B : 5 mm

H,V : Active area

Light spot size $\varnothing = 5\text{mm}$ (BM-5) or $\varnothing = 7.7\text{mm}$ (BM-7) 50cm distance or compatible distance from the LCD surface to detector lens.

test spot position : see Figure a.

measurement instrument : TOPCON's luminance meter BM-5 or BM-7 or compatible (see Figure c).

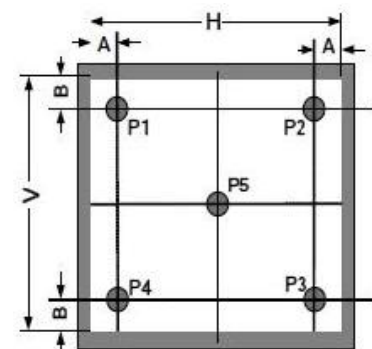

Figure a

Size : $5'' < S \leq 12.3''$ (see Figure b) H,V : Active area

Light spot size $\varnothing = 5\text{mm}$ (BM-5) or $\varnothing = 7.7\text{mm}$ (BM-7) 50cm distance or compatible distance from the LCD surface to detector lens.

test spot position : see Figure b.

measurement instrument : TOPCON's luminance meter BM-5 or BM-7 or compatible (see Figure c).

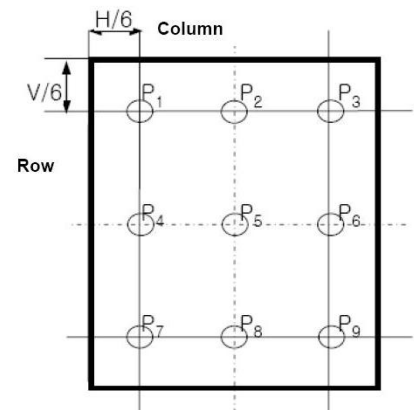

Figure b

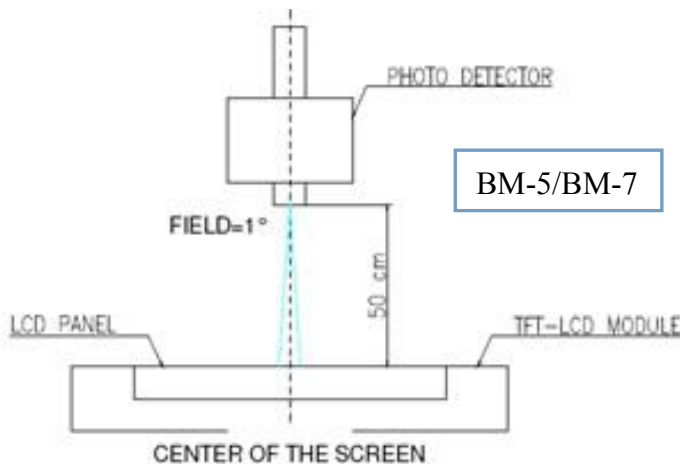
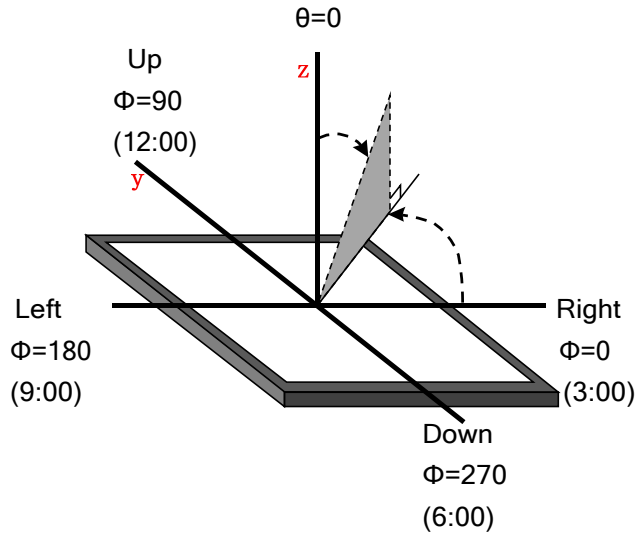

Figure c

FIG.3.The definition of viewing angle



8. Environmental / Reliability Tests

No	Test Item	Condition	Remarks
1	High Temperature Operation	Ts= +85°C, 96hrs	Note 1 IEC60068-2-2, GB2423. 2-89
2	Low Temperature Operation	Ta= -30°C, 96hrs	Note 2 IEC60068-2-1 GB2423.1-89
3	High Temperature Storage	Ta= +95°C, 120hrs	IEC60068-2-2 GB2423. 2-89
4	Low Temperature Storage	Ta= -40°C, 120hrs	IEC60068-2-1 GB/T2423.1-89
5	High Temperature & Humidity Storage	Ta= +60°C, 90% RH max,120 hours	IEC60068-2-3 GB/T2423.3-2006
6	Thermal Shock (Non-operation)	-40°C 30 min ~ +95°C 30 min Change time: 5min, 30 Cycle	Start with cold temperature, end with high temperature IEC60068-2-14, GB2423.22-87
7	Electro Discharge (Operation) Static	C=150pF, R=330 Ω, 5 points/panel Air:±8KV, 5 times; Contact: ±4KV, 5 times; (Environment: 15°C ~ 35°C, 30% ~ 60%, 86Kpa ~ 106Kpa)	IEC61000-4-2 GB/T17626.2-1998
8	Vibration (Non-operation)	Frequency range: 10~55Hz, Stroke: 1.mm Sweep: 10Hz~55Hz~10Hz 2 hours for each direction of X .Y. Z. (package condition)	IEC60068-2-6 GB/T2423.5-1995
9	Shock (Non-operation)	60G 6ms, ± X, ±Y , ± Z 3 times for each direction	IEC60068-2-27 GB/T2423.5-1995
10	Package Drop Test	Height: 80 cm, 1 corner, 3 edges, 6 surfaces	IEC60068-2-32 GB/T2423.8-1995

Note: 1. Ts is the temperature of panel's surface.
2. Ta is the ambient temperature of sample.
3. The size of sample is 5pcs.

10. Packing

Packing Method

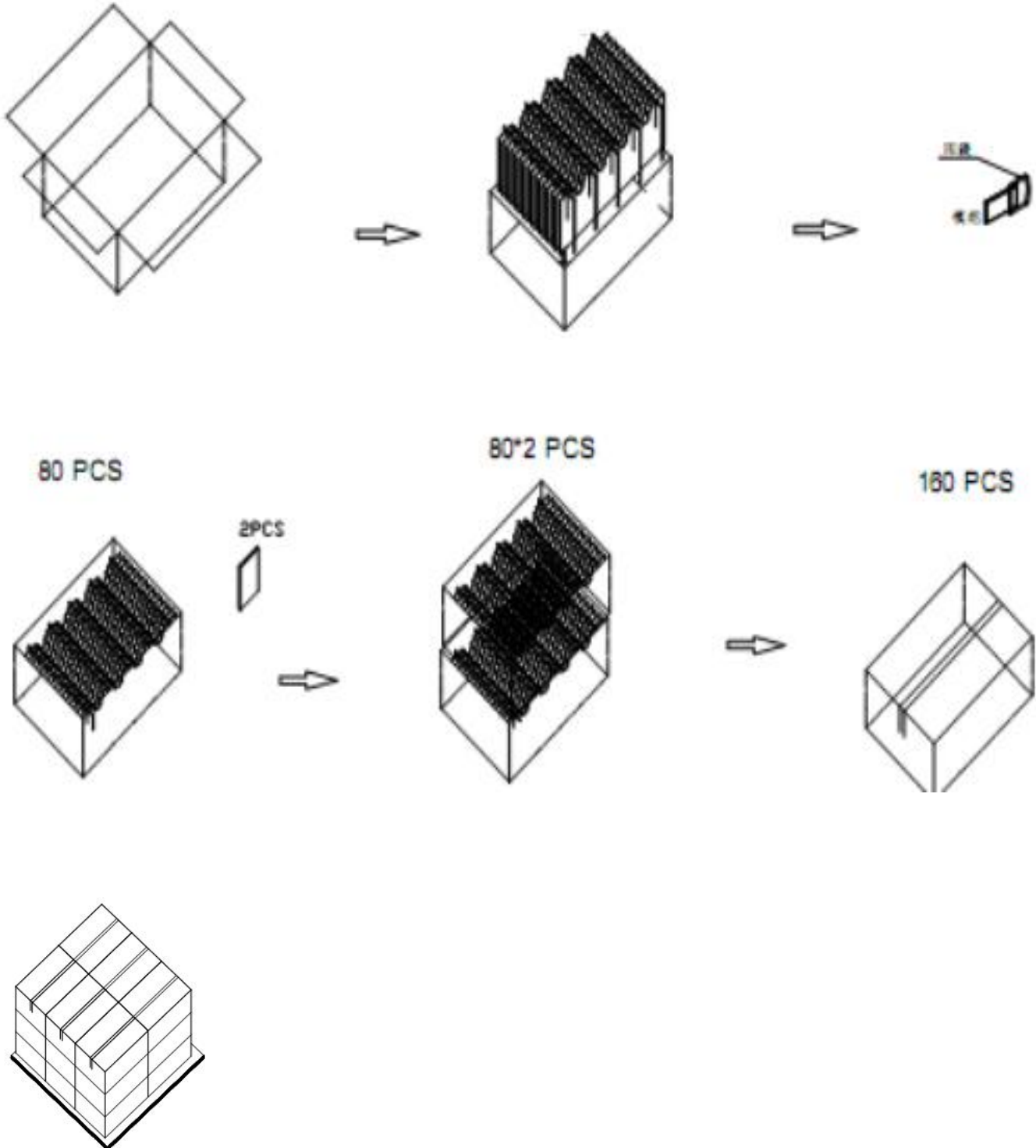

11. TFT-LCD Module Inspection Criteria

11.1 Scope

The incoming inspection standards shall be applied to TFT - LCD Modules (hereinafter Called "Modules") that supplied by Dalian Good Display Co., Ltd.

11.2 Incoming Inspection

The customer shall inspect the modules within twenty calendar days of the delivery date (the "inspection period") at its own cost. The result of the inspection (acceptance or rejection) shall be recorded in writing, and a copy of this writing will be promptly sent to The seller, If the results of the inspecting from buyer does not send to the seller within twenty Calendar days of the delivery date. The modules shall be regards as acceptance. Should the customer fail to notify the seller within the inspection period, the buyers Right to reject the modules shall be lapsed and the modules shall be deemed to have Been accepted by the buyer

11.3 Inspection Sampling

- 3.1. Lot size: Quantity per shipment lot per model
 - 3.2. Sampling type: Normal inspection, Single sampling
 - 3.3. Inspection level: II
 - 3.4. Sampling table: MIL-STD-105E
 - 3.5. Acceptable quality level (AQL)
- Major defect: AQL=0.65 Minor defect: AQL=1.00

11.4 Inspection Conditions

4.1 Ambient conditions:

- a. Temperature: Room temperature $25 \pm 5^{\circ}\text{C}$
- b. Humidity: $(60 \pm 10) \% \text{RH}$
- c. Illumination: Single fluorescent lamp non-directive (300 to 700 Lux)

4.2 Viewing distance

The distance between the LCD and the inspector's eyes shall be at least 35 ± 5 cm.

4.3 Viewing Angle

U/D: $45^{\circ} / 45^{\circ}$, L/R: $45^{\circ} / 45^{\circ}$

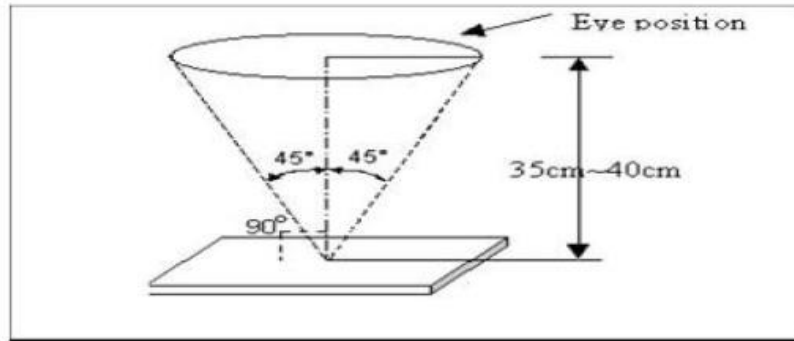

11.5 Inspection Criteria

Defects are classified as major defects and minor defects according to the degree of Defectiveness defined herein.

11.5.1 Major defect

Item No	Items to be inspected	Inspection Standard
5.1.1	All functional defects	1) No display 2) Display abnormally 3) Short circuit 4) line defect
5.1.2	Missing	Missing function component
5.1.3	Crack	Glass Crack

11.5.2 Minor defect

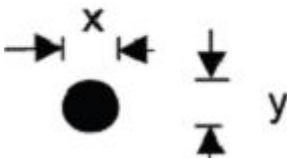
Item No	Items to be inspected	Inspection standard	
5.2.1	Spot Defect Including Black spot White spot Pinhole Foreign particle Polarizer dirt	For dark/white spot is defined	
		$\varphi = (x+y) / 2$ 	
		Size φ (mm)	Acceptable Quantity
		$\varphi < 0.2$	Ignore
	$0.2 \leq \varphi \leq 0.5$	N \leq 4	
	$\varphi > 0.5$	Not allowed	

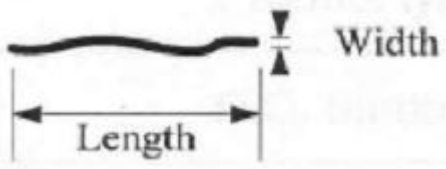
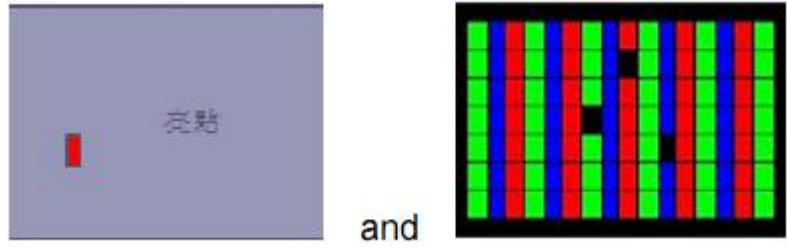
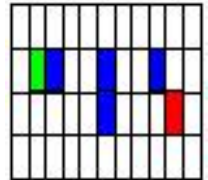
5.2.2	Line Defect Including Black line White line Scratch	Define:		
				
		Width(mm) Length(mm)		Acceptable Quantity
		W<0.05		Ignore
		0.05≤W≤0.1 0.3≤L≤3.0		N≤5
L>3.0		Not allowed		
5.2.3	Polarizer Dent/Bubble	Sizeφ(mm)		Acceptable Quantity
		Φ<0.2		Ignore
		0.2 ≤Φ≤0.5		N≤4
		Φ>0.5		Not allowed
5.2.4	Electrical Dot Defect	Bright and Black dot define:		
				
				
		Two Adjacent Dot		
		Inspection pattern: Full white、 Full black、 Red、 green and blue screens		
		Item		Acceptable Quantity
Single Dot	Adjacent 2dots			Note
Black dot defect		5	1	5
Bright dot defect		4	0	4
Total Dot				7

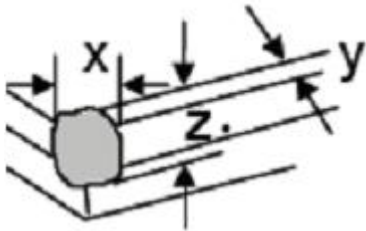
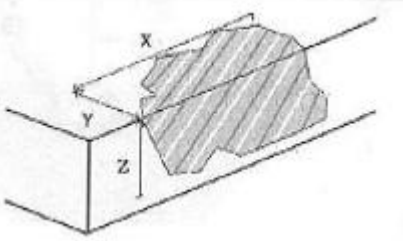
5.2.5	Glass defect		
		1. Corner Fragment:	
		Size(mm)	Acceptable Quantity
		$X \leq 3\text{mm}$ $Y \leq 1\text{mm}$ $Z \leq T$	Ignore T: Glass thickness X: Length Y: Width Z: thickness
		2. Side Fragment:	
			
Size(mm)		Acceptable Quantity	
$X \leq 5.0\text{mm}$ $Y \leq 1\text{mm}$ $Z \leq T$		T: Glass thickness X: Length Y: Width Z: thickness	

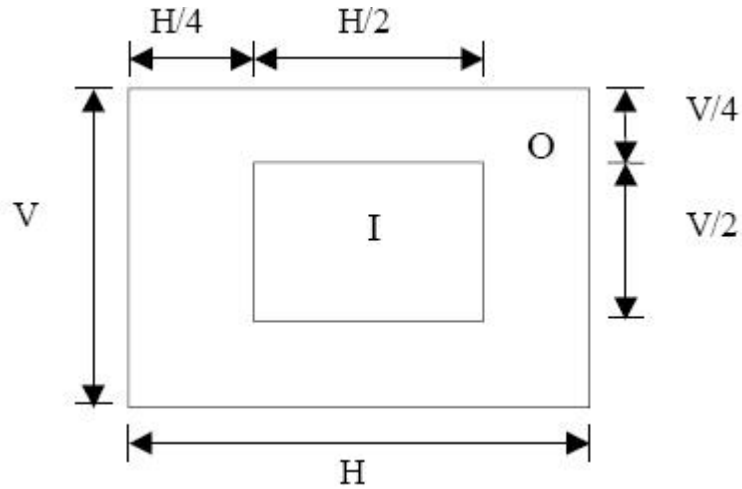

I area & O area

- Note:
- 1). Dot defect is defined as the defective area of the dot area is larger than 50% of the dot area.
 - 2). The distance between two bright dot defects (red, green, blue, and white) should be larger than 15mm.
 - 3). The distance between black dot defects or black and bright dot defects should be more than 5mm apart.
 - 4). Polarizer bubble is defined as the bubble appears on active display area. The defect of polarizer bubble shall be ignored if the polarizer bubble appears on the outside of active display area.

11.6 Mechanics specification

As for the outside dimension, weight of the modules, please refer to product specification
 For more details

12. Precautions for Use of LCD modules

12.1 Handling Precautions

12.1.1. The display panel is made of glass. Do not subject it to a mechanical shock by dropping it from a high place, etc.

12.1.2. If the display panel is damaged and the liquid crystal substance inside it leaks out, be sure not to get any in your mouth, if the substance comes into contact with your skin or clothes, promptly wash it off using soap and water.

12.1.3. Do not apply excessive force to the display surface or the adjoining areas since this may cause the color tone to vary.

12.1.4. The polarizer covering the display surface of the LCD module is soft and easily scratched. Handle this polarizer carefully.

12.1.5. If the display surface is contaminated, breathe on the surface and gently wipe it with a soft dry cloth. If still not completely clear, moisten cloth with one of the following solvents:

- Isopropyl alcohol
- Ethyl alcohol

Solvents other than those mentioned above may damage the polarizer. Especially, do not use the following:

- Water
- Ketene
- Aromatic solvents

12.1.6. Do not attempt to disassemble the LCD Module.

12.1.7. If the logic circuit power is off, do not apply the input signals.

12.1.8. To prevent destruction of the elements by static electricity, be careful to maintain an optimum work environment.

12.1.8.1. Be sure to ground the body when handling the LCD Modules.

12.1.8.2. Tools required for assembly, such as soldering irons, must be properly ground.

12.1.8.3. To reduce the amount of static electricity generated, do not conduct assembly and other work under dry conditions.

12.1.8.4. The LCD Module is coated with a film to protect the display surface. Be care when peeling off this protective film since static electricity may be generated.

12.2 Storage Precautions

12.2.1. When storing the LCD modules, avoid exposure to direct sunlight or to the light of fluorescent lamps.

12.2.2. The LCD modules should be stored under the storage temperature range. If the LCD modules will be stored for a long time, the recommend condition is:

Temperature : 0°C ~ 40°C Relatively humidity: ≤80%

12.2.3. The LCD modules should be stored in the room without acid, alkali and harmful gas.

12.3 Transportation Precautions

The LCD modules should be no falling and violent shocking during transportation, and also should avoid excessive press, water, damp and sunshine.