



8.8 inch Bar LCD Panel Series



GDS088JZA31QE

Dalian Good Display Co., Ltd.

Table of Contents

1. Record of Revision.....	3
2. General Specifications.....	4
3. Input/Output Terminals.....	5
4. Absolute Maximum Rating.....	6
5. Timing characteristics.....	6
6. Optical Characteristics.....	16
7. Environmental / Reliability Tests.....	18
8. Mechanical Drawing.....	19
9. Packing.....	20
10. TFT-LCD Module Inspection Criteria.....	21
11. Precautions for Use of LCD modules.....	26

2. General Specifications

Feature		Spec
Characteristics	Size	8.8 inch
	Resolution	1280(horizontal)*320(Vertical)
	Interface	LVDS
	Connect type	Connector
	Display Colors	16.7M
	Technology type	a-Si
	Pixel pitch (mm)	0.1695*0.1695
	Pixel Configuration	R.G.B.-Stripe
	Display Mode	Normally White
	Driver IC	EK79202
	Viewing Direction	6 O'clock
	Gray Inversion Direction	12 O'clock
Mechanical	LCM (W x H x D) (mm)	229.66*67.50*3.50
	Active Area(mm)	216.96*54.24
	Weight (g)	97g
	LED Numbers	36 LEDs

Note 1: Requirements on Environmental Protection: RoHs

Note 2: LCM weight tolerance: +/- 5%

3. Input/Output Terminals

Pin No	Signal	I/O	Description
1	NC	P	No connection
2~3	VDD	P	DC-DC circuit supply voltage(2.3-3.6V)
4	NC	/	No connection
5	RESET	P	Global reset pin
6	STBYB	P	Standby mode
7	GND	P	Ground
8	RXIN0-	I	- LVDS differential data input
9	RXIN0+	I	+ LVDS differential data input
10	GND	P	Ground
11	RXIN1-	I	- LVDS differential data input
12	RXIN1+	I	+ LVDS differential data input
13	GND	P	Ground
14	RXIN2-	I	- LVDS differential data input
15	RXIN2+	P	+ LVDS differential data input
16	GND	I	GND
17	RXCLKIN-	I	- LVDS differential clock input
18	RXCLKIN+	P	+ LVDS differential clock input
19	GND	I	GND
20	RXIN3-	I	- LVDS differential data input
21	RXIN3+	I	+ LVDS differential data input
22	GND	P	Ground
23	SDA(NC)	P	No connection
24	SCL(NC)	P	No connection
25	GND	P	Ground
26	CS(NC)	I	No connection
27	NC	/	No connection
28	LVBIT	/	6-bit / 8-bit input select for LVDS mode
29	NC	I	No connection
30	GND	P	Ground
31	LEDK-	P	LED Cathode
32	LEDK-	P	LED Cathode
33	NC	/	No connection
34	NC	/	No connection
35	NC	P	No connection
36	NC	/	No connection
37	NC	/	No connection
38	NC	P	No connection
39	LEDA+	P	LED Anode
40	LEDA+	P	LED Anode

4. Absolute Maximum Rating

Item	Symbol	MIN	Typ	MAX	Unit	Remark
Supply Voltage	V _{DD}	2.3	-	3.6	V	-
Operating Temperature	T _{OPR}	-20	-	70	°C	-
Storage Temperature	T _{STG}	-30	-	80	°C	

5. Timing characteristics

5.1 ELECTRICAL CHARACTERISTICS

Item	Symbol	MIN	TYP	MAX	Unit	Remark
VDD Voltage	VDD	-	3.3	-	V	
VDDIO Voltage	VDDIO	-	3.3	-	V	
VSP Voltage	VSP	4.5	5.0	6	V	
VSN Voltage	VSN	-6	-5.0	-4.5	V	
VGH Voltage	VGH	11	18	24	V	
VGL Voltage	VGL	-17	-12	-6	V	
VGL_REG Voltage	VGL_REG	-15	-10	-4.5	V	

5.2 LED Driving Conditions

Item	Symbol	MIN	TYP	MAX	Unit	Remark
Forward Current	I _F	-	180	-	mA	
Forward Voltage	V _F	11.8	12.8	13.8	V	
Backlight Power consumption	W _{BL}	-	2.304	-	W	
LED Lifetime		-	30000	-	Hrs	

Note 1: Each LED: I_F =20 mA, V_F =3.2+/-0.2V.

Note 2: Optical performance should be evaluated at Ta=25°C only.

Note 3: If LED is driven by high current, high ambient temperature & humidity condition. The life Time of LED will be reduced. Operating life means brightness goes down to 50% initial brightness. Typical operating life time is estimated data.

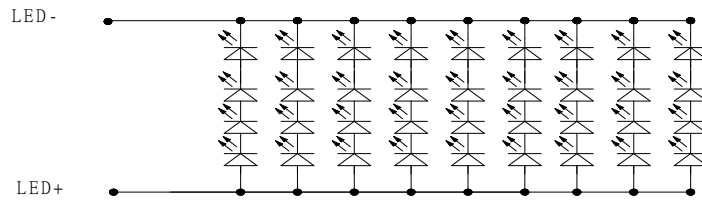

CIRCUIT DIAGRAM (4串 9并)

Figure: LED connection of backlight(Constant Current)

5.3 LVDS Interface

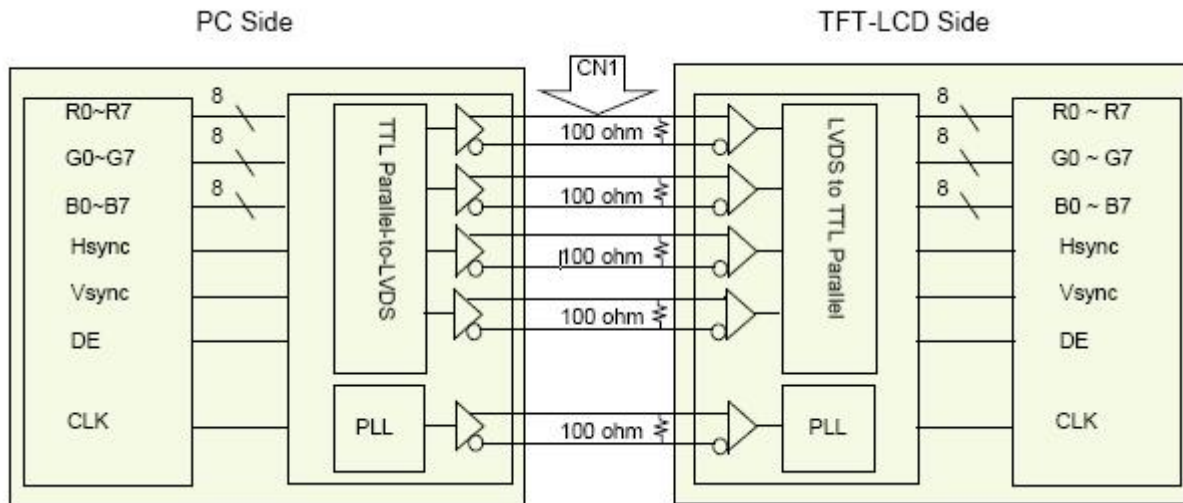

5.4 LVDS mode AC electrical Characteristics

Parameter	Symbol	Spec.			Unit	Condition
		Min.	Typ.	Max.		
Clock frequency	R_{xFCLK}	30	-	TBD	MHz	Refer to input timing table for each display resolution
Input data skew margin	T_{RSKM}	500	-	-	ps	$ VID = 200mV$ $R_{xVCM} = 1.2V$ $R_{xFCLK} = 81MHz$
Clock high time	T_{LVCH}	-	$4/(7 * R_{xFCLK})$	-	ns	
Clock low time	T_{LVCL}	-	$3/(7 * R_{xFCLK})$	-	ns	
PLL wake-up time	T_{enPLL}	-	-	150	us	

Table 13.1: LVDS mode AC electrical characteristics

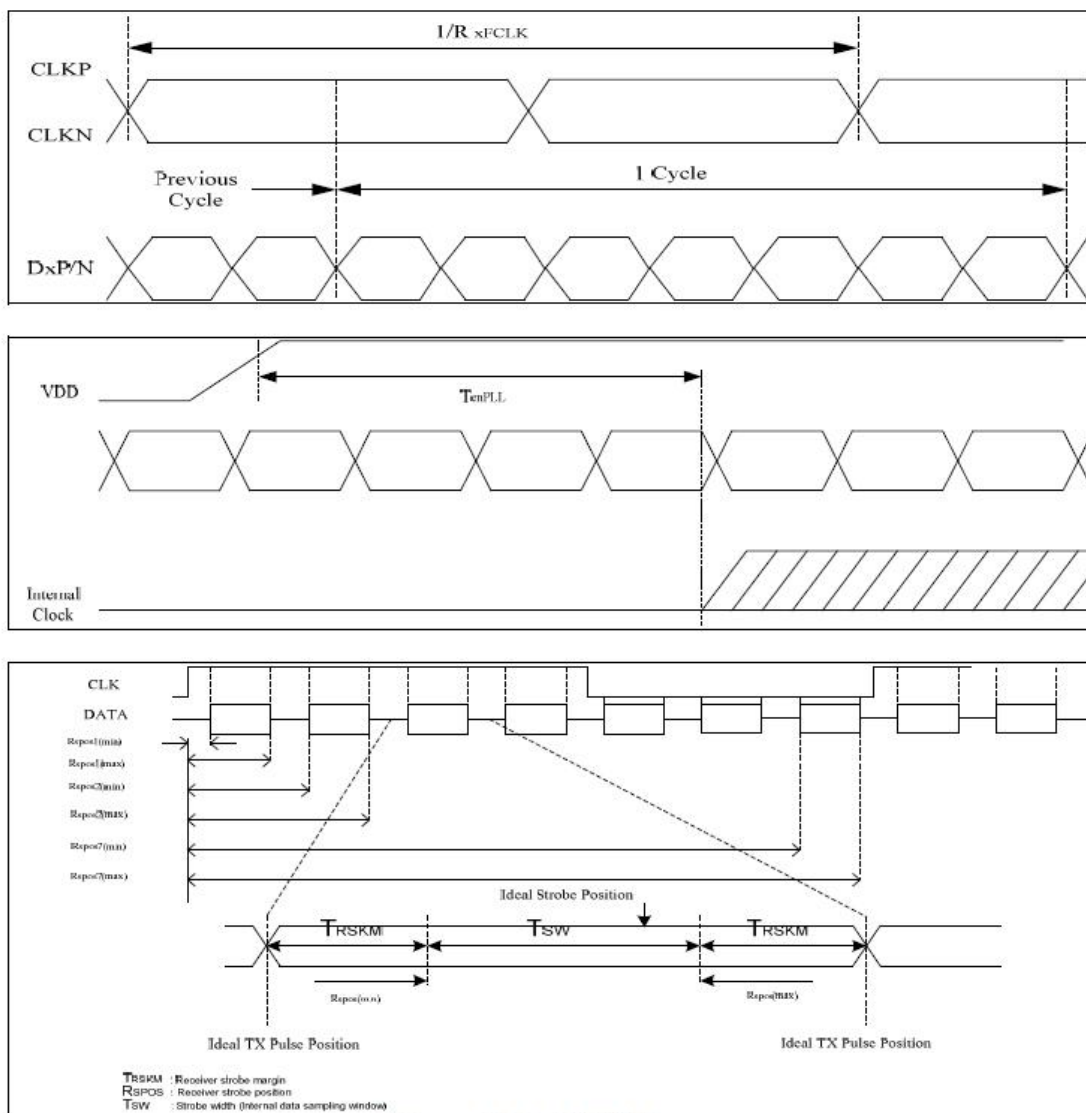

Figure 13.3: LVDS figure

5.5 LVDS DC electrical Characteristics

(VDD=VDDIO=VDDIF=2.3 to 3.6V, VSS=VSSA=VSS_IF=0V, TA=-20 to +85°C)

Parameter	Symbol	Min.	Typ.	Max.	Unit	Condition
Differential input high threshold voltage	R _{XVTH}	+0.1	0.2	0.3	V	R _{XVCM} =1.2V
Differential input low threshold voltage	R _{XVTL}	-0.3	-0.2	-0.1	V	
Input voltage range (singled-end)	R _{XVIN}	0.7	-	1.7	V	
Differential input common mode voltage	R _{XVCM}	1	1.2	1.4	V	V _{ID} =0.2
Differential input impedance	Z _{ID}	80	100	125	ohm	
Differential input voltage	V _{ID}	0.2	-	0.6	V	
Differential input leakage current	I _{LCLVDS}	-10	-	+10	uA	
LVDS Digital Operating Current	I _{VDDMIPI}	-	15	20	mA	F _{DCLK} =80MHz, VDD=3.3V, Input pattern: 55h->Aah->55h->Aah
LVDS Digital Stand-by Current	I _{STMIPI}	-	-	250	uA	Clock & all Functions are stopped

Single-end Signals

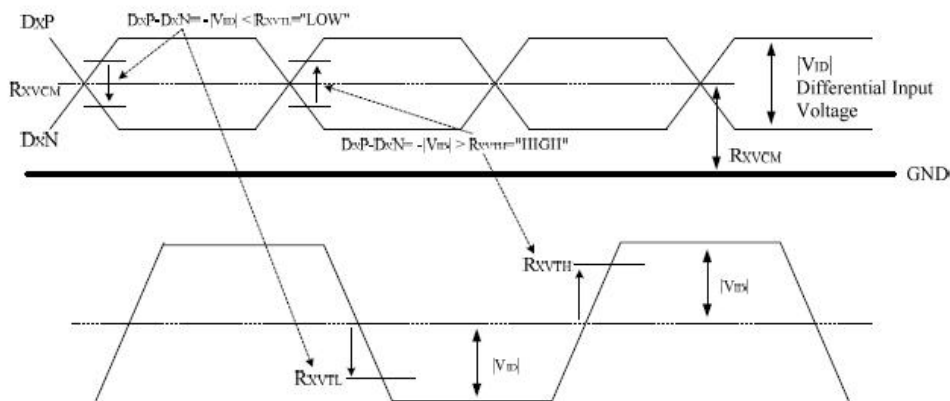

5.6 Timing

Item	Symbol	Min.	Typ.	Max.	Unit
PCLK Frequency	FPCLK	-	36	-	MHz
Horizontal Synchronization	Hsync	-	10	-	PCLK
Horizontal Back Porch	HBP	-	20	-	PCLK
Horizontal Front Porch	HFP	-	72	-	PCLK
Hsync+HBP+HFP	-	-	102	-	PCLK
Horizontal Display Area	Hd	-	1280	-	PCLK
Horizontal cycle	-	-	1382	-	PCLK
Vertical Synchronization	Vsync	-	10	-	Line
Vertical Back Porch	VBP	-	70	-	Line
Vertical Front Porch	VFP	-	20	-	Line
Hsync+VBP+VFP	-	-	100	-	Line
Vertical Display Area	Vd	-	320	-	Line
Vertical cycle	-	-	420	-	Line
Frame Rate	-	-	60	-	Hz

5.7 Data input format for LVDS

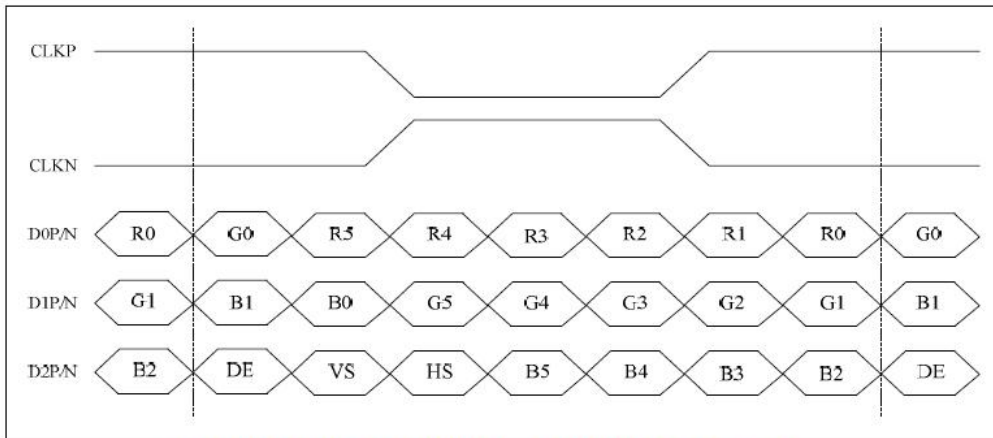

6-bit LVDS input (LVBIT=L, LVFMT=Don't care)

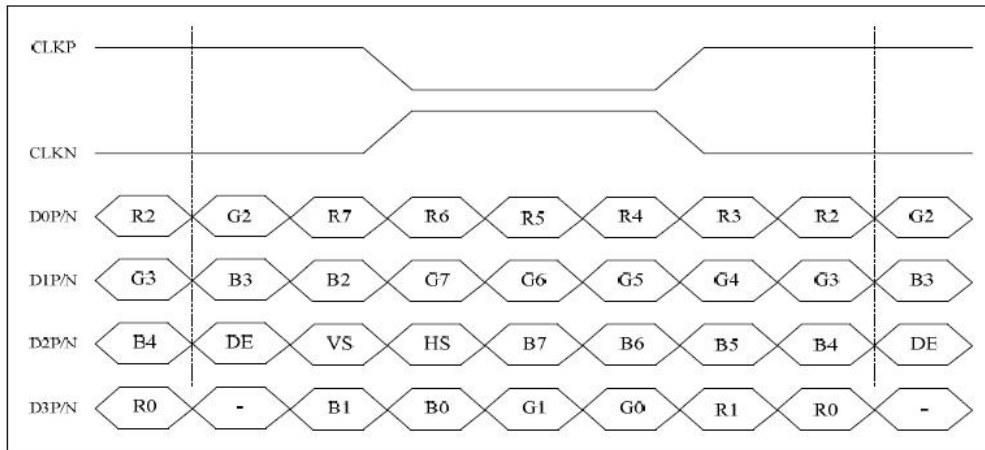

8-bit LVDS input (LVBIT=H, LVFMT=L)

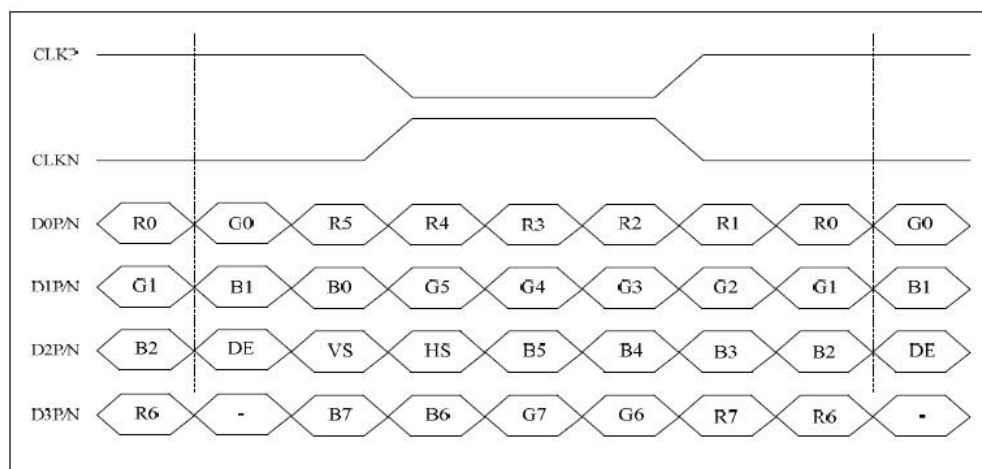

8-bit LVDS input(LVBIT=H, LVFMT=H)

5.8 Power Sequence

5.8.1 Power on Sequence

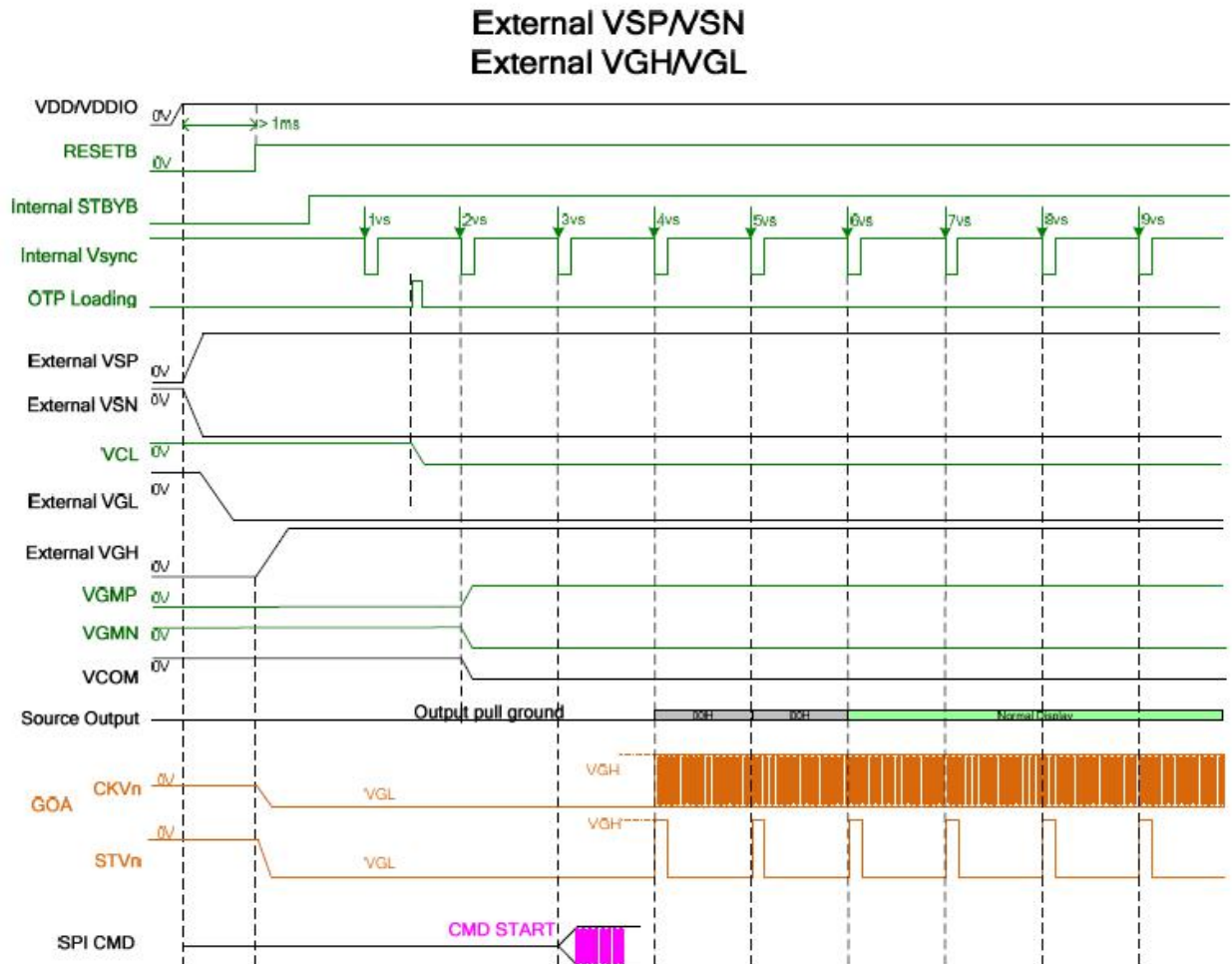

5.8.2 Power off Sequence

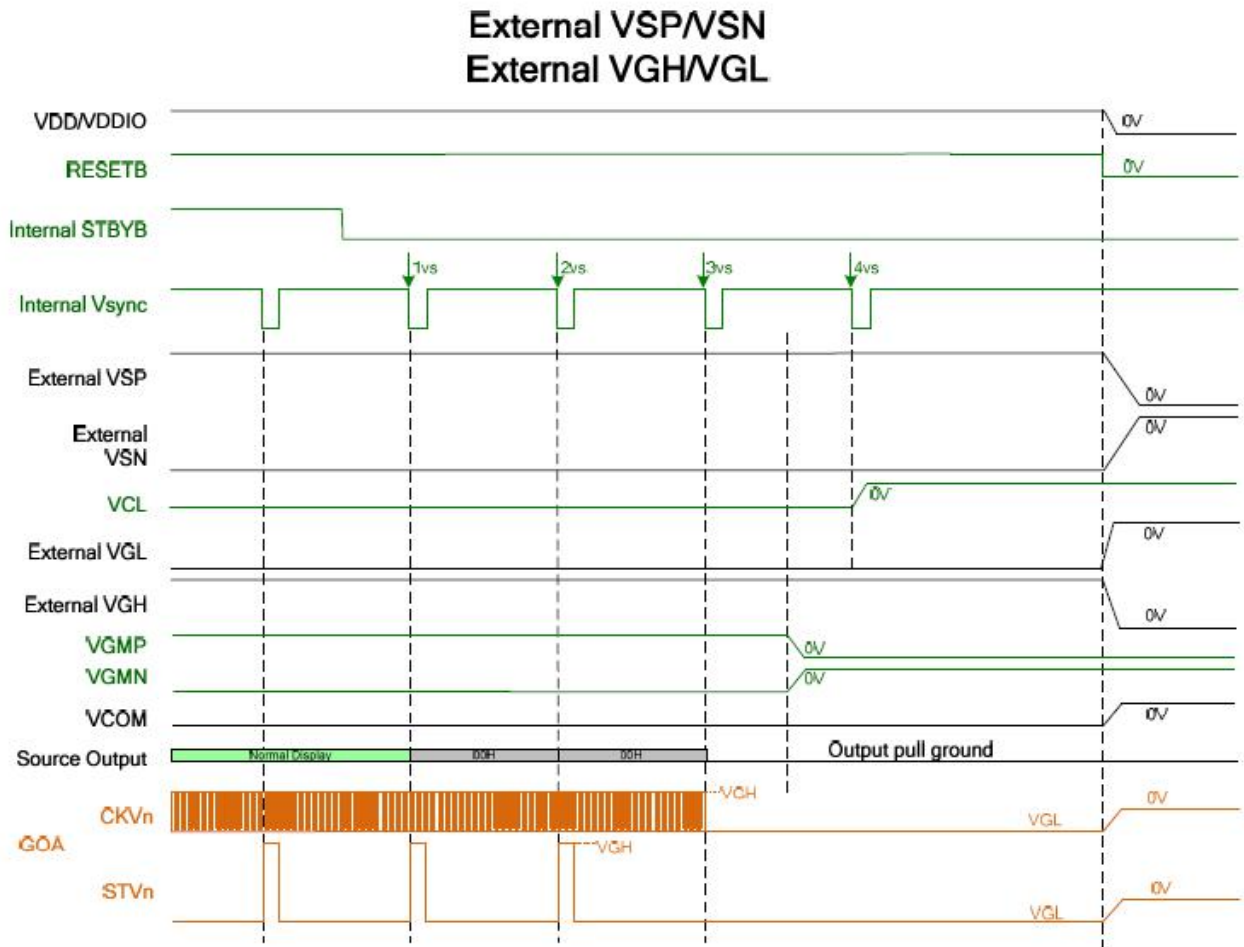

6 Optical Characteristics

Items		Symbol	Condition	Min.	Typ.	Max.	Unit	Remark	Note
Response time		Tr+Tf	-	-	25	50	ms	FIG.1	Note4
Contrast Ratio		CR		500	700	-	-	FIG.2	Note1
Surface luminance		LV	$\theta = 0^\circ$	360	400	-	cd/m2	FIG.2	Note2
Luminance uniformity		Yu	$\theta = 0^\circ$	-	80	-	%	FIG.2	Note3
NTSC		-	$\theta = 0^\circ$	60	70	-	%	FIG.2	Note5
Viewing angle		θ Cr>10	θ_T	-	55	-	deg	FIG.3	Note6
			θ_B	-	65	-	deg	FIG.3	
			θ_L	-	65	-	deg	FIG.3	
			θ_R	-	65	-	deg	FIG.3	
Chromaticity	Red	R _X	$\theta = 0^\circ$ $\phi = 0^\circ$ Ta=25°	0.574	0.594	0.614	-	FIG.2 CIE1931	Note5
		R _Y		0.288	0.308	0.328	-		
	Green	G _X		0.296	0.316	0.336	-		
		G _Y		0.550	0.570	0.590	-		
	Blue	B _X		0.118	0.138	0.158	-		
		B _Y		0.133	0.153	0.173	-		
	White	W _X		0.281	0.301	0.321	-		
		W _Y		0.316	0.336	0.356	-		

Note1. Definition of contrast ratio

Contrast ratio(Cr) is defined mathematically by the following formula. For more information see FIG.2.

$$\text{Contrast ratio} = \frac{\text{Luminance measured when LCD on the "White" state}}{\text{Luminance measured when LCD on the "Black" state}}$$

For contrast ratio, Surface Luminance, Luminance uniformity and CIE,the testing data is base on TOPCON' s BM-5 or BM-7 photo detector or compatible.

Note2. Definition of surface luminance.

Surface luminance is the luminance with all pixels displaying white. For more information see FIG.2.

L_v = Average Surface Luminance with all white pixels(P1,P2,P3,,Pn)

Note3. Definition of luminance uniformity

The luminance uniformity in surface luminance is determined by measuring luminance at each test position 1 through n, and then dividing the maximum luminance of n points luminance by minimum luminance of n points luminance. For more information see FIG.2.

$$YU = \frac{\text{Minimum surface luminance with all white pixels (P1,P2,P3,.....,Pn)}}{\text{Maximum surface luminance with all white pixels (P1,P2,P3,.....,Pn)}}$$

Note4. Definition of response time

The response time is defined as the LCD optical switching time interval between “White” state and “Black” state. Rise time (Tr) is the time between photo detector output intensity changed from 90% to 10%. And fall time (Tf) is the time between photo detector output intensity changed from 10% to 90%.

For additional information see FIG1.

Note5. Definition of color chromaticity (CIE1931)

CIE (x,y) chromaticity, The x,y value is determined by screen active area center position P5. For more information see FIG.2.

Note6. Definition of viewing angle

Viewing angle is the angle at which the contrast ratio is greater than 10. Angles are determined for the horizontal or x axis and the vertical or y axis with respect to the z axis which is normal to the LCD surface. For more information see FIG.3.

For viewing angle and response time testing, the testing data is base on Autronic-Melchers’ s ConoScope or DMS series Instruments or compatible.

FIG.1. The definition of response Time

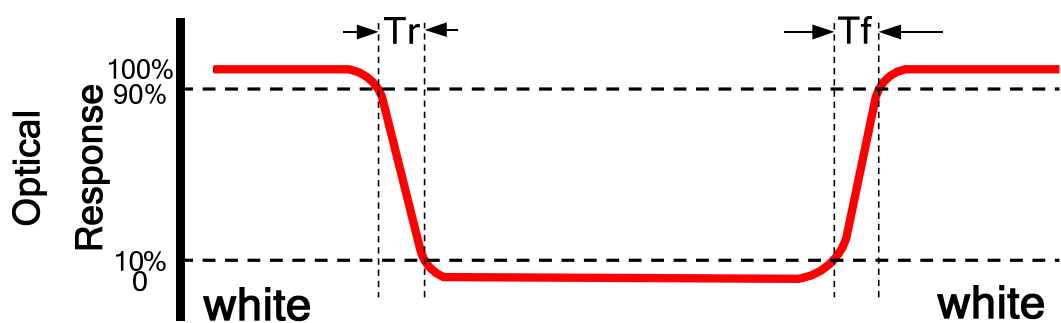

FIG.2. Measuring method for contrast ratio, surface luminance,

luminance uniformity, CIE (x,y) chromaticity

Size : $S \leq 5''$ (see Figure a) A : 5 mm B : 5 mm

H,V : Active area

Light spot size $\varnothing=5\text{mm}$ (BM-5) or $\varnothing=7.7\text{mm}$ (BM-7) 50cm distance or compatible distance from the LCD surface to detector lens.

test spot position : see Figure a.

measurement instrument : TOPCON's luminance meter BM-5 or BM-7 or compatible (see Figure c).

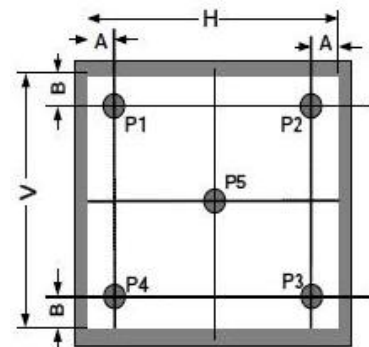

Figure a

Size : $5'' < S \leq 12.3''$ (see Figure b) H,V : Active area

Light spot size $\varnothing=5\text{mm}$ (BM-5) or $\varnothing=7.7\text{mm}$ (BM-7) 50cm distance or compatible distance from the LCD surface to detector lens.

test spot position : see Figure b.

measurement instrument : TOPCON's luminance meter BM-5 or BM-7 or compatible (see Figure c).

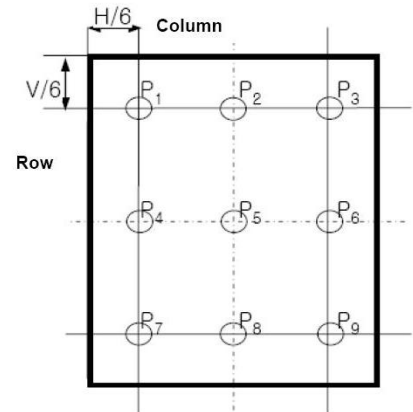

Figure b

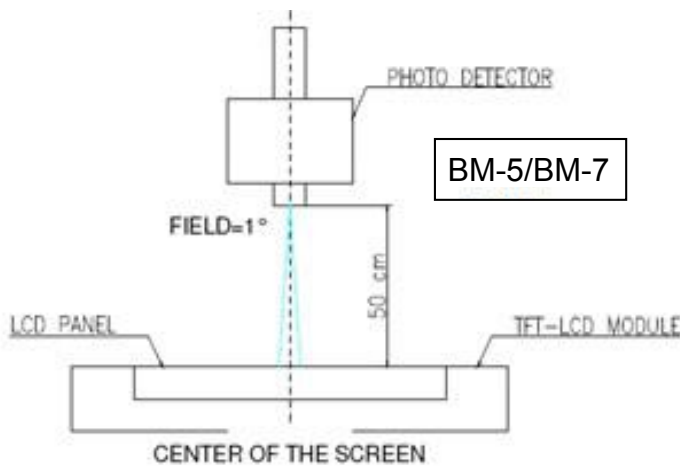
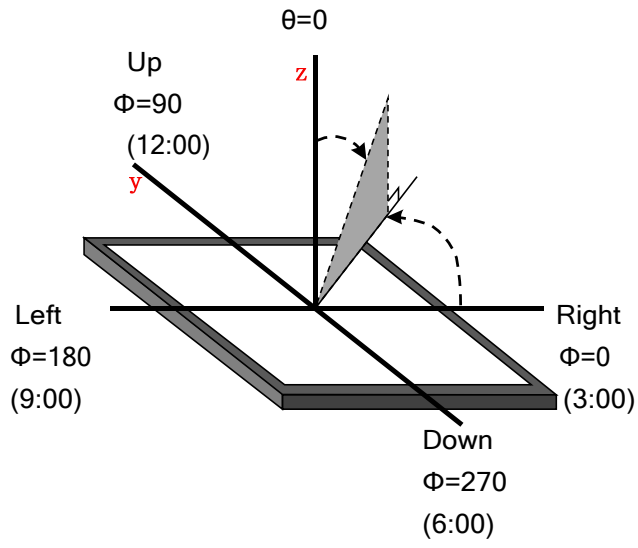

Figure c

FIG.3.The definition of viewing angle



7 Environmental / Reliability Tests

No	Test Item	Condition	Remarks
1	High Temperature Operation	Ts= +70°C, 96hrs	Note 1 IEC60068-2-2, GB2423. 2-89
2	Low Temperature Operation	Ta= -20°C, 96hrs	Note 2 IEC60068-2-1 GB2423.1-89
3	High Temperature Storage	Ta= +80°C, 120hrs	IEC60068-2-2 GB2423. 2-89
4	Low Temperature Storage	Ta= -30°C, 120hrs	IEC60068-2-1 GB/T2423.1-89
5	High Temperature & Humidity Storage	Ta= +70°C, 90% RH max, 120 hours	IEC60068-2-3 GB/T2423.3-2006
6	Thermal Shock (Non-operation)	-20°C 30 min ~ +70°C 30 min Change time: 5min, 30 Cycle	Start with cold temperature, end with high temperature IEC60068-2-14, GB2423.22-87
7	Electro Discharge (Operation) Static	C=150pF, R=330 Ω, 5 points/panel Air:±8KV, 5 times; Contact: ±4KV, 5 times; (Environment: 15°C ~ 35°C, 30% ~ 60%, 86Kpa ~ 106Kpa)	IEC61000-4-2 GB/T17626.2-1998
8	Vibration (Non-operation)	Frequency range: 10~55Hz, Stroke: 1mm Sweep: 10Hz~55Hz~10Hz 2 hours for each direction of X .Y. Z. (package condition)	IEC60068-2-6 GB/T2423.5-1995
9	Shock (Non-operation)	60G 6ms, ± X, ±Y , ± Z 3 times for each direction	IEC60068-2-27 GB/T2423.5-1995
10	Package Drop Test	Height: 80 cm, 1 corner, 3 edges, 6 surfaces	IEC60068-2-32 GB/T2423.8-1995

- Note:1. Ts is the temperature of panel's surface.
2. Ta is the ambient temperature of sample.
3. The size of sample is 5pcs.

9 Packing

Packing Method

TBD

10 .TFT-LCD Module Inspection Criteria

10.1 Scope

The incoming inspection standards shall be applied to TFT – LCD Modules (hereinafter Called "Modules") that supplied by Dalian Good Display Co., Ltd.

10.2 Incoming Inspection

The customer shall inspect the modules within twenty calendar days of the delivery date (the “inspection period”) at its own cost. The result of the inspection (acceptance or rejection) shall be recorded in writing, and a copy of this writing will be promptly sent to The seller, If the results of the inspecting from buyer does not send to the seller within twenty Calendar days of the delivery date. The modules shall be regards as acceptance. Should the customer fail to notify the seller within the inspection period, the buyers Right to reject the modules shall be lapsed and the modules shall be deemed to have Been accepted by the buyer

10.3 Inspection Sampling

- 3.1. Lot size: Quantity per shipment lot per model
- 3.2. Sampling type: Normal inspection, Single sampling
- 3.3. Inspection level: II
- 3.4. Sampling table: MIL-STD-105E
- 3.5. Acceptable quality level (AQL)
Major defect: AQL=0.65 Minor defect: AQL=1.50

10.4 Inspection Conditions

4.1 Ambient conditions:

- a. Temperature: Room temperature $25 \pm 5^{\circ}\text{C}$
- b. Humidity: $(60 \pm 10) \% \text{RH}$
- c. Illumination: Single fluorescent lamp non-directive (300 to 700 Lux)

4.2 Viewing distance

The distance between the LCD and the inspector’s eyes shall be at least 35 ± 5 cm.

4.3 Viewing Angle

U/D: $45^{\circ} / 45^{\circ}$, L/R: $45^{\circ} / 45^{\circ}$

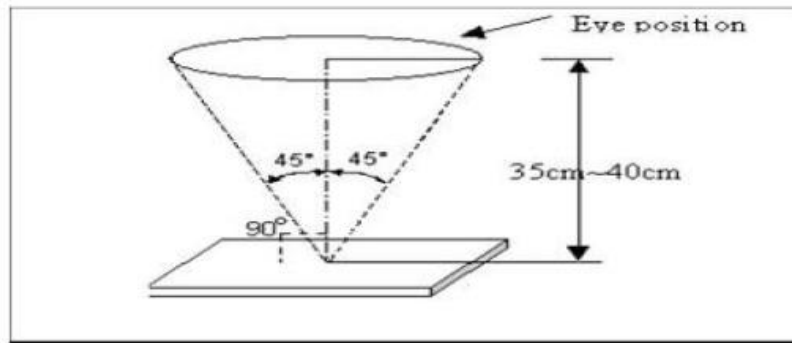

10.5 Inspection Criteria

Defects are classified as major defects and minor defects according to the degree of Defectiveness defined herein.

10.5.1 Major defect

Item No	Items to be inspected	Inspection Standard
5.1.1	All functional defects	1) No display 2) Display abnormally 3) Short circuit 4) line defect
5.1.2	Missing	Missing function component
5.1.3	Crack	Glass Crack

10.5.2 Minor defect

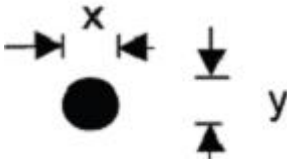
Item No	Items to be inspected	Inspection standard	
5.2.1	Spot Defect Including Black spot White spot Pinhole Foreign particle Polarizer dirt	For dark/white spot is defined $\phi = (x+y) / 2$ 	
		Size ϕ (mm)	Acceptable Quantity
		$\phi \leq 0.2$	Ignore
		$0.2 < \phi \leq 0.3$	$N \leq 5$
		$0.3 < \phi$	Not allowed

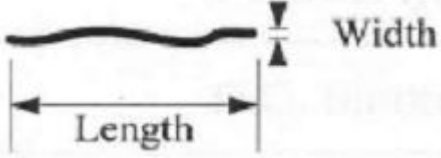
5.2.2	Line Defect Including Black line White line Scratch	Define:	
			
		Width(mm) Length(mm)	Acceptable Quantity
		$W \leq 0.05$	Ignore
		$0.05 < W \leq 0.1$ $0.3 < L \leq 3.0$	$N \leq 3$
$L > 3.0$	Not allowed		

5.2.3	Polarizer Dent/Bubble	Size ϕ (mm)	Acceptable Quantity
		$\Phi \leq 0.2$	Ignore
		$0.2 < \Phi \leq 0.3$	$N \leq 2$
		$\Phi > 0.3$	Not allowed

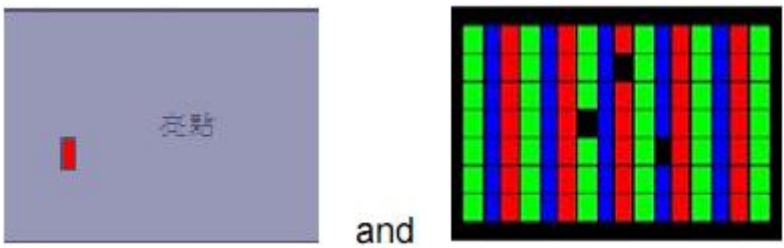
5.2.4	Electrical Dot Defect	Bright and Black dot define:			
					
		Two Adjacent Dot			
		Inspection pattern: Full white , Full black , Red , green and blue screens			
		Item	Acceptable Quantity		
			Single Dot	Adjacent 2dots	Total
Black dot defect	4	2	4		
Bright dot defect	2	1	2		
Total Dot			6		

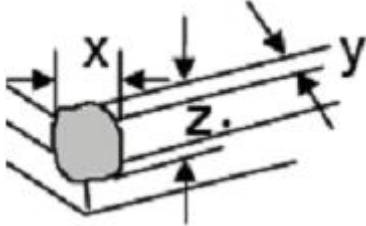
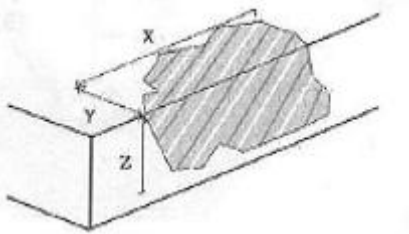
5.2.5	Glass defect		
		1. Corner Fragment:	
		Size(mm)	Acceptable Quantity
		$X \leq 3\text{mm}$ $Y \leq 1\text{mm}$ $Z \leq T$	Ignore T: Glass thickness X: Length Y: Width Z: thickness
		2. Side Fragment: 	
		Size(mm)	Acceptable Quantity
$X \leq 5.0\text{mm}$ $Y \leq 1\text{mm}$ $Z \leq T$	T: Glass thickness X: Length Y: Width Z: thickness		

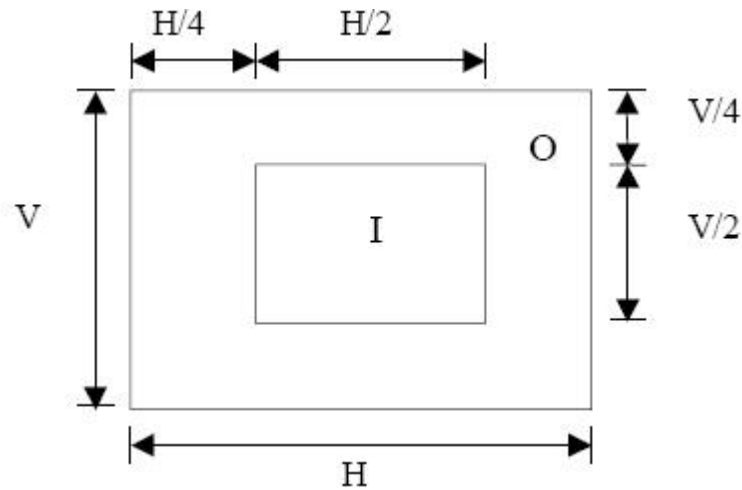

I area & O area

- Note:
- 1). Dot defect is defined as the defective area of the dot area is larger than 50% of the dot area.
 - 2). The distance between two bright dot defects (red, green, blue, and white) should be larger than 15mm.
 - 3). The distance between black dot defects or black and bright dot defects should be more than 5mm apart.
 - 4). Polarizer bubble is defined as the bubble appears on active display area. The defect of polarizer bubble shall be ignored if the polarizer bubble appears on the outside of active display area.

10.6 Mechanics specification

As for the outside dimension, weight of the modules, please refer to product specification
For more details

11. Precautions for Use of LCD modules

11.1 Handling Precautions

11.1.1. The display panel is made of glass. Do not subject it to a mechanical shock by dropping it from a high place, etc.

11.1.2. If the display panel is damaged and the liquid crystal substance inside it leaks out, be sure not to get any in your mouth, if the substance comes into contact with your skin or clothes, promptly wash it off using soap and water.

11.1.3. Do not apply excessive force to the display surface or the adjoining areas since this may cause the color tone to vary.

11.1.4. The polarizer covering the display surface of the LCD module is soft and easily scratched. Handle this polarizer carefully.

11.1.5. If the display surface is contaminated, breathe on the surface and gently wipe it with a soft dry cloth. If still not completely clear, moisten cloth with one of the following solvents:

- Isopropyl alcohol
- Ethyl alcohol

Solvents other than those mentioned above may damage the polarizer. Especially, do not use the following:

- Water
- Ketene
- Aromatic solvents

11.1.6. Do not attempt to disassemble the LCD Module.

11.1.7. If the logic circuit power is off, do not apply the input signals.

11.1.8. To prevent destruction of the elements by static electricity, be careful to maintain an optimum work environment.

11.1.8.1. Be sure to ground the body when handling the LCD Modules.

11.1.8.2. Tools required for assembly, such as soldering irons, must be properly ground.

11.1.8.3. To reduce the amount of static electricity generated, do not conduct assembly and other work under dry conditions.

11.1.8.4. The LCD Module is coated with a film to protect the display surface. Be care when peeling off this protective film since static electricity may be generated.

11.2 Storage Precautions

11.2.1. When storing the LCD modules, avoid exposure to direct sunlight or to the light of fluorescent lamps.

11.2.2. The LCD modules should be stored under the storage temperature range. If the LCD modules will be stored for a long time, the recommend condition is:

Temperature : 0°C ~ 40°C Relatively humidity: ≤80%

11.2.3. The LCD modules should be stored in the room without acid, alkali and harmful gas.

11.3 Transportation Precautions

The LCD modules should be no falling and violent shocking during transportation, and also should avoid excessive press, water, damp and sunshine.